

20 and 25 Series Temperature Swichgage® Instrument 2 and 2-1/2 in. (51 and 64 mm) Dial



Features

- Combination Indicating Gage and Limit Switch
- Critical/High Temperature Limit Switch Is Visible and Adjustable (Most Models)
- Switch Can Activate Alarms and/or Shut Down Equipment
- Contact Grounds Through Case

* Products covered by this bulletin comply with EMC Council directive 89/336/EEC regarding electromagnetic compatibility as noted.

The 20 Series (2 inch/51 mm dial) and the 25 Series (2-1/2 inch/64 mm dial) Swichgage models are diaphragm-actuated, temperature-indicating gages, with built-in electrical switches for tripping alarms and/or shutdown devices.

Ranges are available from 32-120°F (0-45°C) thru 300-440°F (160-220°C).

The gage mechanism is enclosed in a steel case coated to resist corrosion. A polycarbonate, break resistant lens and a polished, stainless steel bezel help protect this rugged, built-to-last instrument.

These vapor actuated gages feature a sealed capillary tube and a sensing bulb. When subjected to heat, the liquid in the sensing bulb changes to vapor creating pressure against the diaphragm mechanism. The diaphragm translates this vapor pressure into a mechanical gage reading.

For series 20T and 25T, the gage pointer acts as a temperature indicator and as one switch pole which completes a circuit when it touches the adjustable limit contact. Contact(s) are grounded through the Swichgage case. They have self-cleaning motion to enhance electrical continuity.

Models 20TE and 25TE have internal snap-acting SPDT switches.

Gage-only models, without contacts (Murphygage® instrument) are also available.

Applications

Industrial engines and equipment in Oil Field, Marine, Irrigation, Construction and Trucking industries. Monitoring Engine Coolant, Crank-case Oil, Transmission Oil.

Specifications

Dial: White on black; U.S.A. standard scale is dual scale °F/°C; others available (see How to Order).

Case: Plated steel; mounting clamp included (except for direct mounting models).

Bezel: Polished stainless steel, standard; others are available (see How to Order).

Pointer: Tempered nickel silver.

Lens: Polycarbonate, high-impact.

Sensing Element: Beryllium copper diaphragm.

Capillary: PVC armored copper; 4 ft. (1.2 m). Stainless steel armor optional.

Sensing Bulb: Copper.*

Gage Accuracy: See accuracy chart, on page 2.

Maximum Temperature: See Temperature Ranges and Factory Settings table on page 2.

Adjustable Limit Contact (20T and 25T): SPST contact; pilot duty only, 2 A @ 30 VAC/ VDC; Ground path through encasement. Normally Closed (NC) when the high limit is met. Normally Open (NO) when pointer is in normal operating range. Contacts are gold flashed silver.

Limit Contact Adjustment: by a 1/16 in. hex wrench thru 100% of the scale.

Limit Contact Wire Leads: 18 AWG (1.0 mm²) x 12 in. (305 mm).

Snap-Switch Rating (20TE and 25TE):

SPDT, 3 A @ 30 VDC inductive; 4 A @ 125 VAC inductive. Snap-Switch Wire Leads: 20 AWG (0.75 mm²) x 12 in. (305 mm).

Unit Weight: 20 Series: 12.7 oz. (0.39 kg).

25 Series Models: 13.8 oz. (0.43 kg).

Unit Dimensions: 20 Series: 4-3/4 x 4-3/4 x 2-3/4 in. (121 x 121 x 70 mm). 25 Series Models: 4-3/4 x 4-3/4 x 3 in. (121 x 121 x 76 mm).

*For optional capillary lengths, engine adaptors, sensing bulbs and range combinations, visit <http://www.fwmurphy.com>.

In order to consistently bring you the highest quality, full-featured products, we reserve the right to change our specifications and designs at any time. MURPHY products and the Murphy logo are registered and/or common law trademarks of Enovation Controls, LLC. This document, including textual matter and illustrations, is copyright protected by Enovation Controls, LLC with all rights reserved. (c) 2013 Enovation Controls, LLC. A copy of the warranty may be viewed or printed by going to <http://fwmurphy.com/warranty>.

Base Models

Coolant or Oil Temperature

20T and 25T Series Swichgag

For these models the gage pointer makes with an adjustable contact to complete a pilot-duty circuit.

20TL and 25TL Swichgag instrument

For use on Ford Worldwide engines. Supplied with special sensing bulb.

20TO Swichgag instrument

Same as 20T with a special dial for Oil Temperature.

20TE and 25TE Swichgag instrument

20TE (was 20ESR) and 25TE (was 25ESR).

Models with internal SPDT snap-switches, instead of the single pole/pointer contact(s). When the switch closes on rising temperature, it becomes Set. As temperature decreases the switch Resets.

20TABS and 25TABS Swichgag instrument

Same as 20/25T with internal SPDT snap-switch for pre-alarm.

Cylinder Head Temperature

20TH and 25TH Swichgag instrument

20TH (was 20TL8133) and 25TH (was 25TL8133). For use on Air Cooled engines.

Direct Mount Models

20TD Swichgag instrument

Same as 20T. Available ranges: 220°F (104°C) or 250°F (121°C). Includes 1/4 x 4 in. (6 x 102 mm) sensing bulb.

20SD Swichgag instrument

Same as 20T. Available ranges: 220°F (104°C) or 250°F (121°C). Includes 11/32 x 1-1/2 in. (9 x 38 mm) sensing bulb.

Gage-Only Models

20TG and 25TG Murphygag

Gages without contact(s).

Temperature Ranges and Factory Settings

NOTES

- Values in () are mathematical conversions from °F to °C—they do not reflect actual second scale range. U.S.A. standard scale is °F/°C.
- For models 20TE and 25TE; the switch trip point cannot be set at either the low or high extreme of the scale. The trip point must allow for the reset differential.
- For adjustable switch models, the trip point is adjustable only over the upper half of the scale.

Ranges Available			Max. Temp.	Std. Settings *			Hi/Lo Settings		20TABS and 25TABS Settings			
Dual Scale Dial		Single Scale					Low	High	Alarm †		Shutdown	
°Fahrenheit	(°Celsius)	°Celsius only	°F (°C)	°F (°C)	°C only	°F (°C)	°F (°C)	°F (°C)	°C only	°F (°C)	°C only	
32 – 120	(0 – 49)	—	185 (85)	110 (43)	—	32 (0)	110 (43)	100 (38)	—	110 (43)	—	
32 – 160	(0 – 71)	0 – 70	215 (102)	150 (66)	66	32 (0)	150 (66)	140 (60)	60	150 (66)	66	
130 – 220	(54 – 104)	45 – 100	260 (127)	210 (99)	85	160 (71)	210 (99)	200 (93)	80	210 (99)	85	
130 – 250	(54 – 121)	50 – 120	310 (154)	210 (99)	97	160 (71)	210 (99)	200 (93)	95	210 (99)	100	
140 – 300	(60 – 149)	60 – 140	340 (172)	275 (135)	130	200 (93)	275 (135)	265 (129)	125	275 (135)	130	
160 – 320	(71 – 160)	70 – 160	370 (192)	300 (149)	150	200 (93)	300 (149)	290 (143)	145	300 (149)	150	
180 – 350	(82 – 177)	—	400 (209)	330 (166)	—	240 (116)	330 (166)	320 (160)	—	330 (166)	—	
300 – 440	(149 – 227)	—	500 (260)	400 (204)	—	300 (149)	400 (204)	390 (199)	—	400 (204)	—	

* Standard setting for 20T, 25T, 20TE and 25TE models.

† SPDT snap-switch is the alarm switch.

Temperature Accuracy Chart

Temperature Range	Lower 1/3 of Scale	Middle 1/3 of Scale	Upper 1/3 of Scale
32 to 120°F (0 to 49°C)	± 12°F (± 6°C)	± 5°F (± 2.4°C)	± 6°F (± 3°C)
32 to 160°F (0 to 71°C)	± 20°F (± 10°C)	± 8°F (± 4.4°C)	± 7°F (± 4°C)
130 to 220°F (54 to 104°C)	± 6°F (± 3°C)	± 3°F (± 1.6°C)	± 4°F (± 2°C)
130 to 250°F (54 to 121°C)	± 9°F (± 5°C)	± 5°F (± 2.4°C)	± 4°F (± 2°C)
140 to 300°F (60 to 149°C)	± 10°F (± 5.2°C)	± 6°F (± 3°C)	± 5°F (± 2.4°C)
160 to 320°F (71 to 160°C)	± 10°F (± 5.2°C)	± 5°F (± 2.4°C)	± 5°F (± 2.4°C)
180 to 350°F (82 to 177°C)	± 12°F (± 6°C)	± 5°F (± 2.4°C)	± 5°F (± 2.4°C)
300 to 440°F (149 to 227°C)	± 9°F (± 5°C)	± 5°F (± 2.4°C)	± 4°F (± 2°C)

Maximum Temperature

MAXIMUM AMBIENT TEMPERATURE: -40° (-40°) thru 150° (66°)

RANGE	MAXIMUM PROCESS TEMPERATURE
≤250° (120°)	120% OF FULL SCALE
300° (140°)	350° (198°)
≥320° (160°)	120% OF FULL SCALE

Dimensions

20 Series Models (typical)

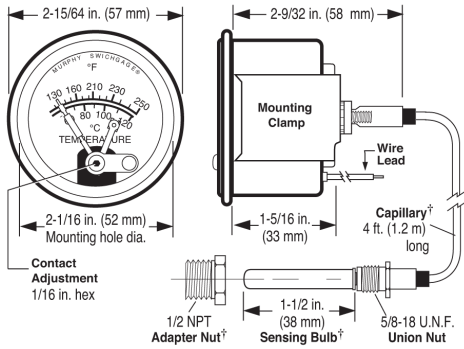

25 Series Models (typical)

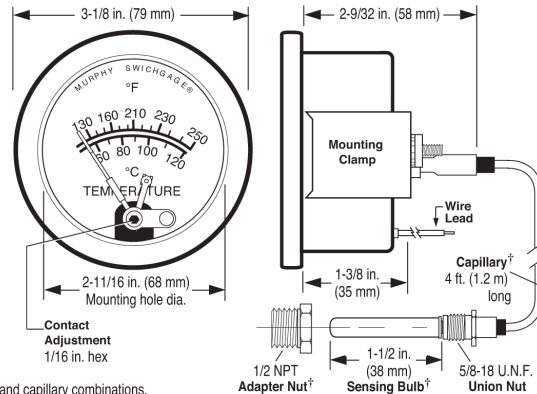

†Standard combinations. See Murphy bulletin T-8428B for optional sensing bulb, engine adaptors and capillary combinations.

Magnetic Switch

INDUCTIVE AND HIGH CURRENT LOADS REQUIRE THE USE OF A MAGNETIC SWITCH. The Swichgag contacts are for light-duty electrical switching to operate alarms or control devices. Murphy manufactures the Magnetic Switch for protection of the light-duty Swichgag limit contacts. Tattletale® Magnetic Switches show the cause of shutdown for applications that include: capacitor discharge or magneto ignitions, battery systems and electric motor driven equipment. Typical wiring diagrams are shown below.

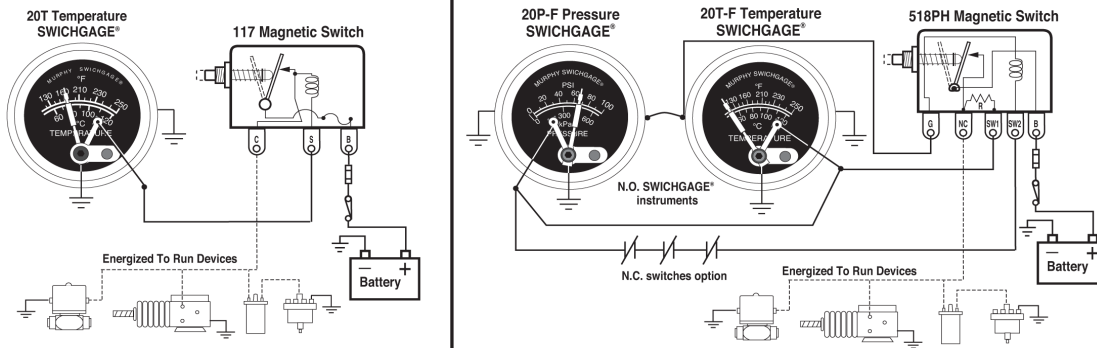

Pre-Alarm Using 20/25TABS

The 20TABS and 25TABS feature a standard limit contact for high temperature equipment shutdown. It also has an internal SPDT snap-switch to signal an alarm before shutting down. When the low side of the snap-switch trips (preset point), on rising temperature, the switch completes a circuit to activate an alarm. If the temperature continues to increase, the face-adjustable pointer contact will make and the shutdown circuit will be completed (see the typical diagram below for reference). The front contact shutdown limit setting (which is adjustable) and the snap-switch are preset at the factory. Refer to "Temperature Ranges and Factory Settings" table on opposite page for settings. For alternative alarm before shutdown, see Magnetic Switch model 760A or 761APH.

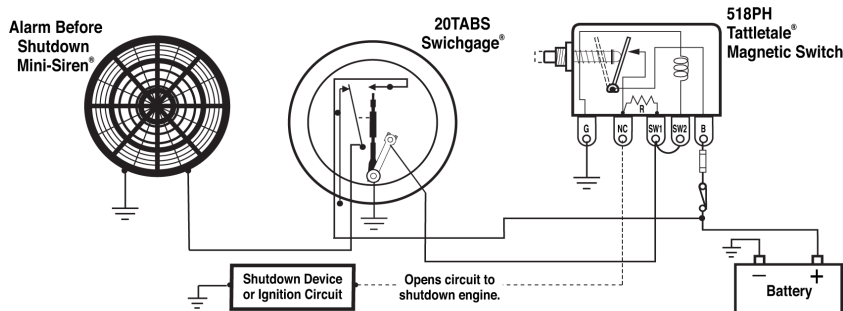

Typical Internal Wiring Diagrams

Pointer shown in the shelf position. Pointer type contact rating: pilot duty 2 A @ 30 VAC/VDC.

Snap-acting switch rating: 3 A @ 30 VDC inductive. 4 A @ 125 VAC inductive.

Pointer Type Contact

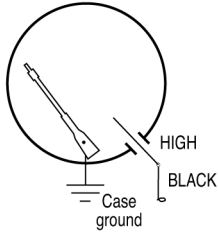

"HL" Hi-Lo Option

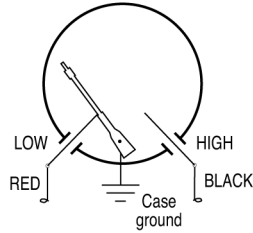

ABS Models

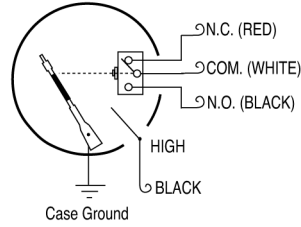

TE Models

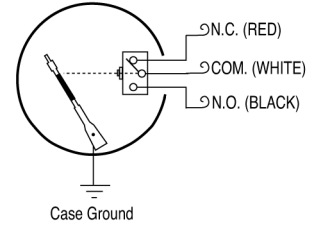

How to Order

To order, use the diagram below. List options in ascending alphabetical order (A-Z). Example: **20T-IP1-250-4**.

Base Model

20T	20TH	25TL
20TL	20TD	25TE
20TO	20SD	25TABS
20TE	20TG	25TH
20TABS	25T	25TG
20TB		

Options[†]

- A = AGF (Argon filled)
- B1 = Black bezel
- B2 = Bezel 05051857 (was "HP")
- B3 = Bezel 05051836 (was "HBB")
- EX = EX proof (explosion proofed)
- EL = EX less case (explosion proofed less case)
- F = "FS" contact (includes "ES" as appropriate)
- HL = High and low contacts
- I = Illumination (for options, see chart below)
- IP1 = Light pipe illumination, 12 VDC
- IP2 = Light pipe illumination, 24 VDC
- K = Knob adjusting face contact
- OS = Oil sealed (Silicone Oil)
- UA = Temperature bulb style A (10050166)*
- UB = Temperature bulb style B (10010061)*
- UC = Temperature bulb style C (10010060)*
- UD = Temperature bulb style D (10000286)*
- UE = Temperature bulb style E (10010084)*
- UF = Temperature bulb style F (10000577)*
- UG = Temperature bulb style G (10000578)*
- UH = Temperature bulb style H (10002466)*
- UK = Temperature bulb style K (10054886)*

[†] Options not available on all models or configurations.
^{*} Specify optional bulb ONLY when not included as standard for temperature **Base Model**, scale/range or capillary length.

Illumination Options

	IP1 / IP2	I
20 Series	x	x ¹
25 Series	N/A	N/A

¹Can be used with standard Clamp Lite Assembly (12 V= 05702176; 24 V= 05702177).

Adapter Nuts^{†††}

1/8 = 1/8-27 NPT	Metric
1/4 = 1/4-18 NPT	M10 = 10 mm x 1.5
3/8 = 3/8-18 NPT	M12 = 12 mm x 1.5
3/8B = 3/8-19 BSPT	M14 = 14 mm x 1.5
3/8K = 3/8 NPSF	M16 = 16 mm x 1.5
- = 1/2-14 NPT ^{††††}	M18 = 18 mm x 1.5
1/2B = 1/2-BSPT	M20 = 20 mm x 1.5
1/2K = 1/2 NPSF	M22 = 22 mm x 1.5
5/8 = 5/8-18 UNF	M24 = 24 mm x 1.5
3/4 = 3/4-14 NPT	
3/4U = 3/4-16 UNF	
7/8 = 7/8-9 UNC	

^{†††}Specific adapter nut must match the sensing bulb.
^{††††}Standard.

Temperature Capillary Armor Type and Length

Capillary Armor Type

Blank = PVC armor, copper capillary

S = Stainless steel armor, copper capillary

Capillary Length (specify after capillary type; example: "S4")

4 = 4 ft. (1.2 m)

Specify other length = Available in 2 ft. increments thru 20 ft.; 5 ft. increments above 20 ft. (0.5 metres increments from 1.5-10 metres; 2 metre increments thru 34 metres. **Specify "M" following length, i.e. 1.5M.**)

Range^{††}

Dual scale (°F/°C)		Single scale (°C)
°F	°C	
120 = 32-120	0-49	70C = 0-70°C
160 = 32-160	0-71	100C = 45-100°C
220 = 130-220	54-104	120C = 50-120°C
250 = 130-250	60-121	140C = 60-140°C
300 = 140-300	60-149	160C = 70-160°C
320 = 160-320	71-160	
350 = 180-350	82-177	
440 = 300-440	149-227	

^{††}Consult factory for availability of dials other than °F/°C. Select scale so your normal operating temperature is in the upper half of the scale.